







Palm Pull Down Kitchen Faucet with Dual Function Head

F823

Specifications:

- Heavy brass construction for durability and reliability
- High arc swivel spout with 360 degree or 140 degree rotation with supplied stop
- Single handle operation allows both volume and temperature control
- Kerox ceramic cartridge ensures life long trouble free service
- Quick and easy installation with top mounting system and quick hose connector
- Dual function brass spray head with spray and aerated flow
- Limited to flow rate of 1.8 gpm (6.8 lpm) at 60 psi
- Stainless steel flex supplies with $\frac{3}{8}$ " comp. connection
- Max deck thickness 1 $\frac{1}{2}$ " (38 mm) with spacer and 2 $\frac{1}{8}$ " (54 mm) without spacer
- 1 $\frac{1}{2}$ " (38 mm) faucet hole size for drilling is recommended
- 8" deck plate for 3 hole installation is available and sold separately
- ADA Compliant

Features:

-  Dual Spray Kitchen Faucet
-  Pull Down Kitchen Spout
-  Magnetic Docking
-  Ceramic Disk Cartridge
-  Heavy brass construction
-  360 Degree Rotation with 140 Degree Lock

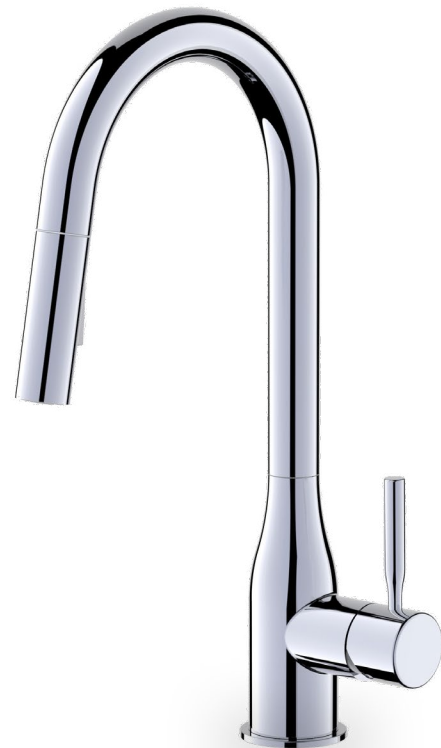

Polished Chrome (CP), Stainless Steel (SS)

Technical Drawing

F823

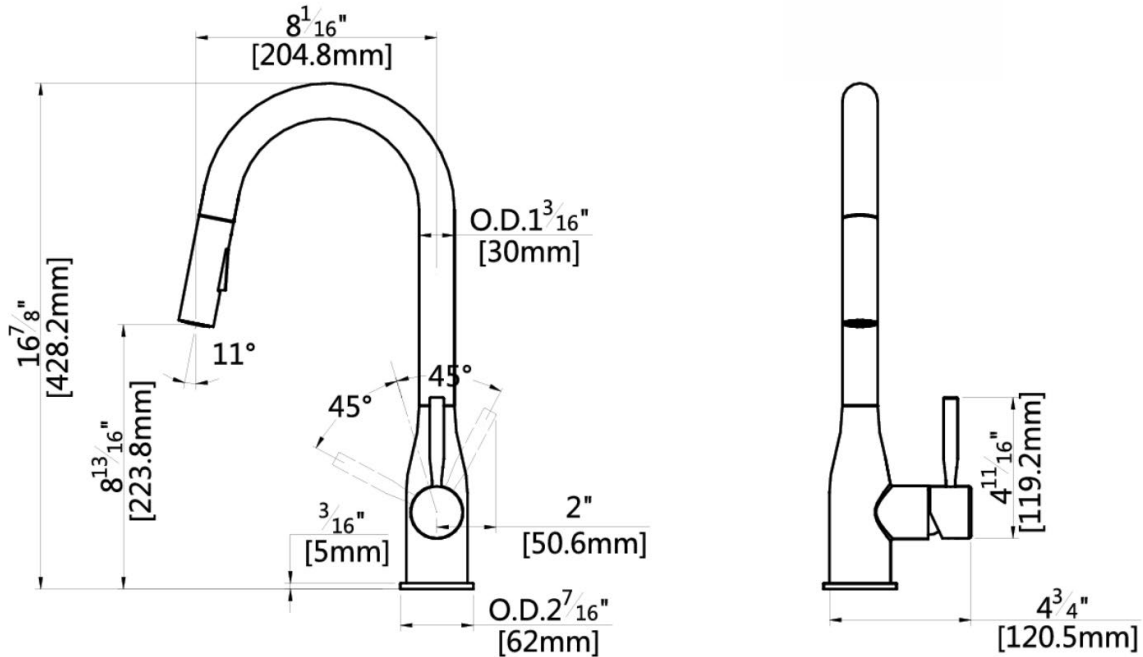

Warranty:

Limited Lifetime Faucet Warranty against material and manufacturing defects for residential use.
2 Year Limited Warranty on all industrial, commercial and business applications.

Codes & Standards:

ANSI/ASME A112.18.1
CSA B125.1
NSF/ANSI/CAN 61: Q < 1
NSF / ANSI / CAN372
IAPMO / cUPC Listed
EPA Watersense Listed
ADA Compliant

Flow Rate:

1.8 gpm (6.8 lpm) at 60 psi

Low Flow Alternative
@1.5 gpm (5.7 lpm) **F823-15**

